

A1

+

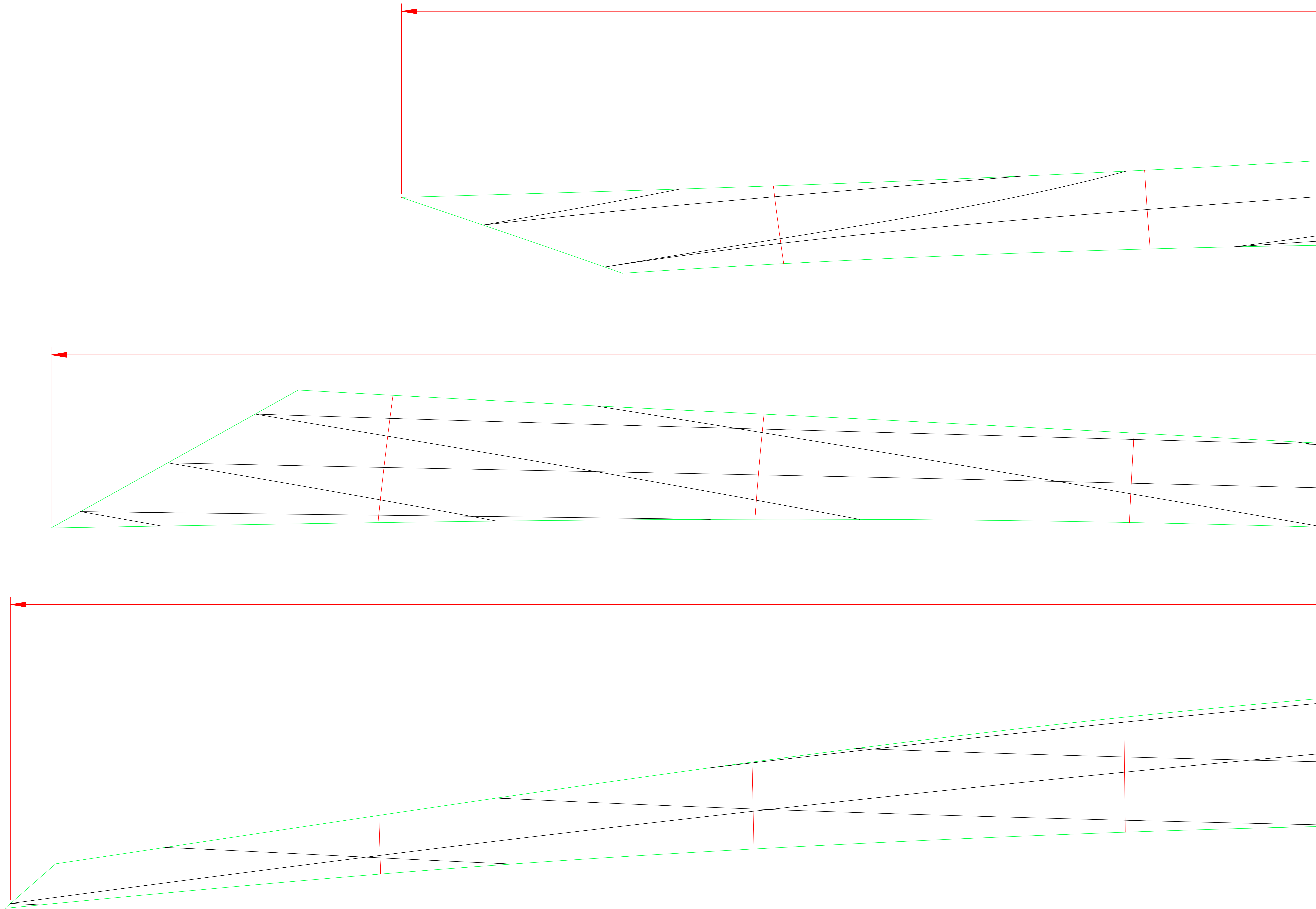

+

+

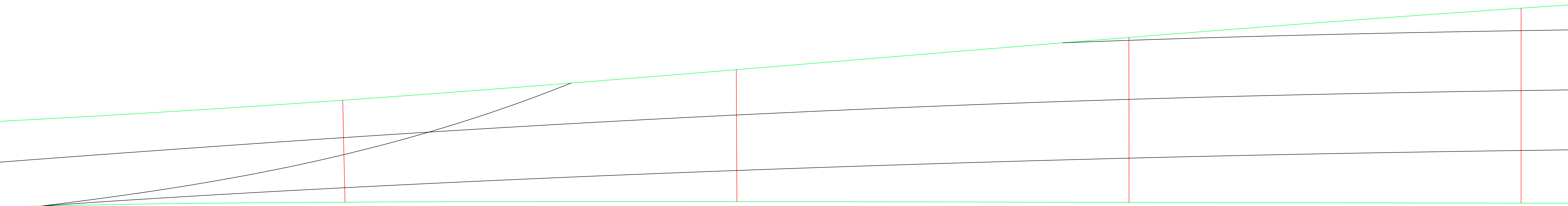

Siskiwit MC Experiment

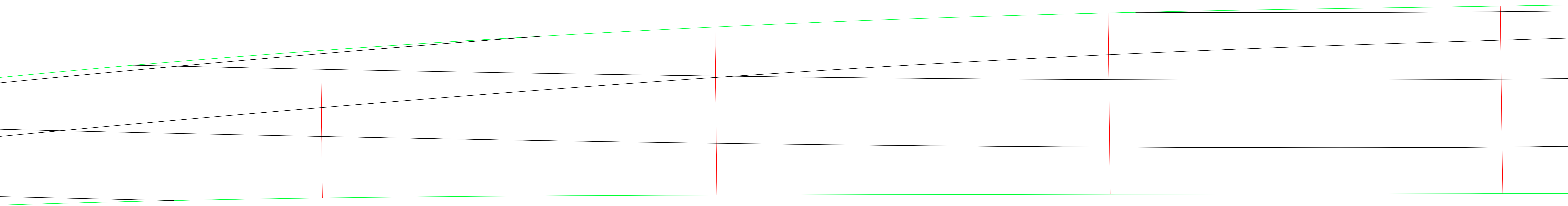
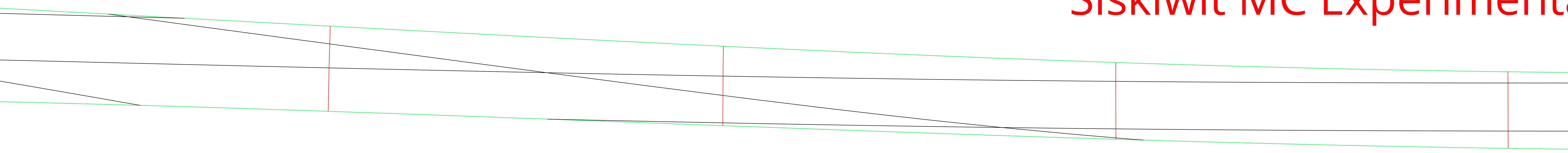

C1

+

15'-3 13/16"

Strake 1

16'-10 11/16"

Experimental Plate Drawing -- www.paddlinglight.com

Strake 2

17'-1 9/16"

Strake 3

+

+

D1

+

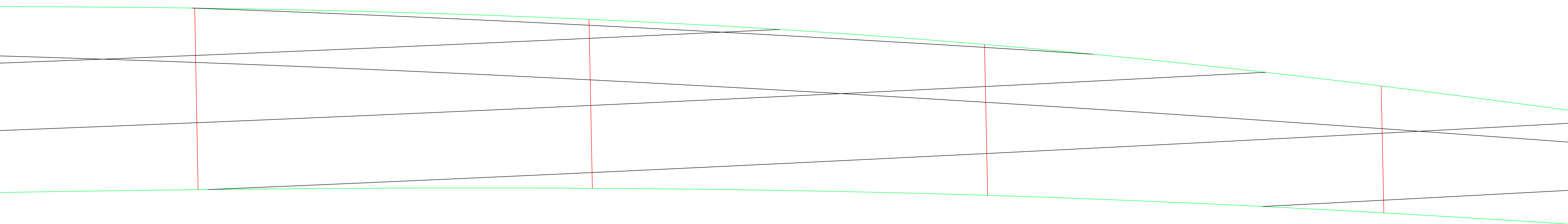
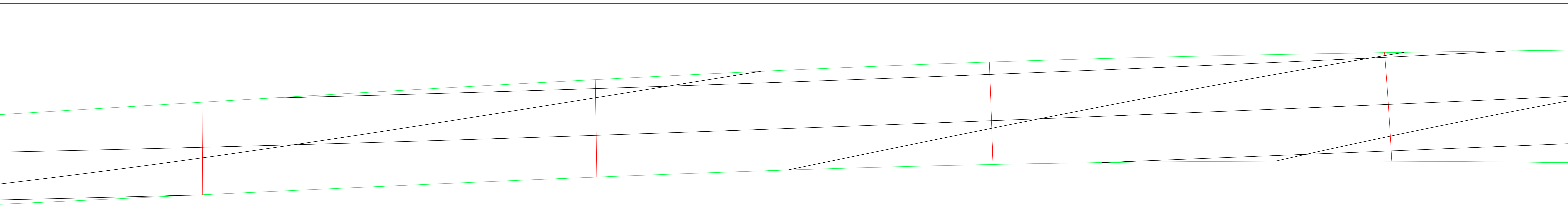
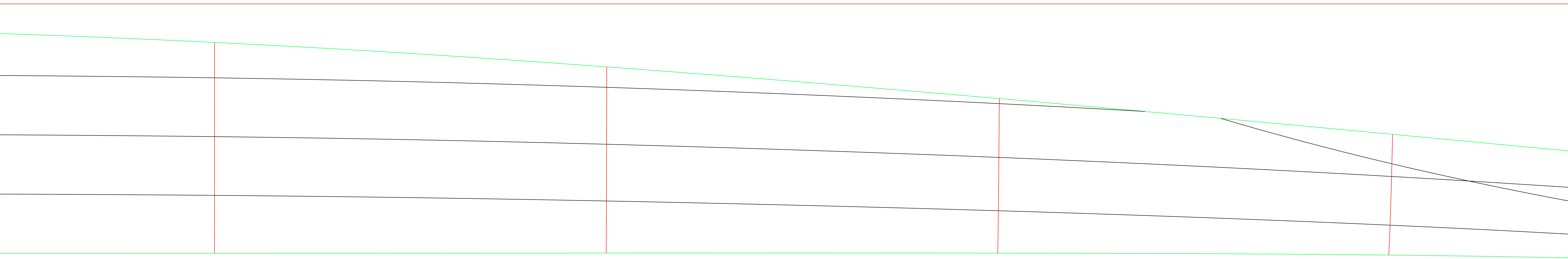

+

+

E1

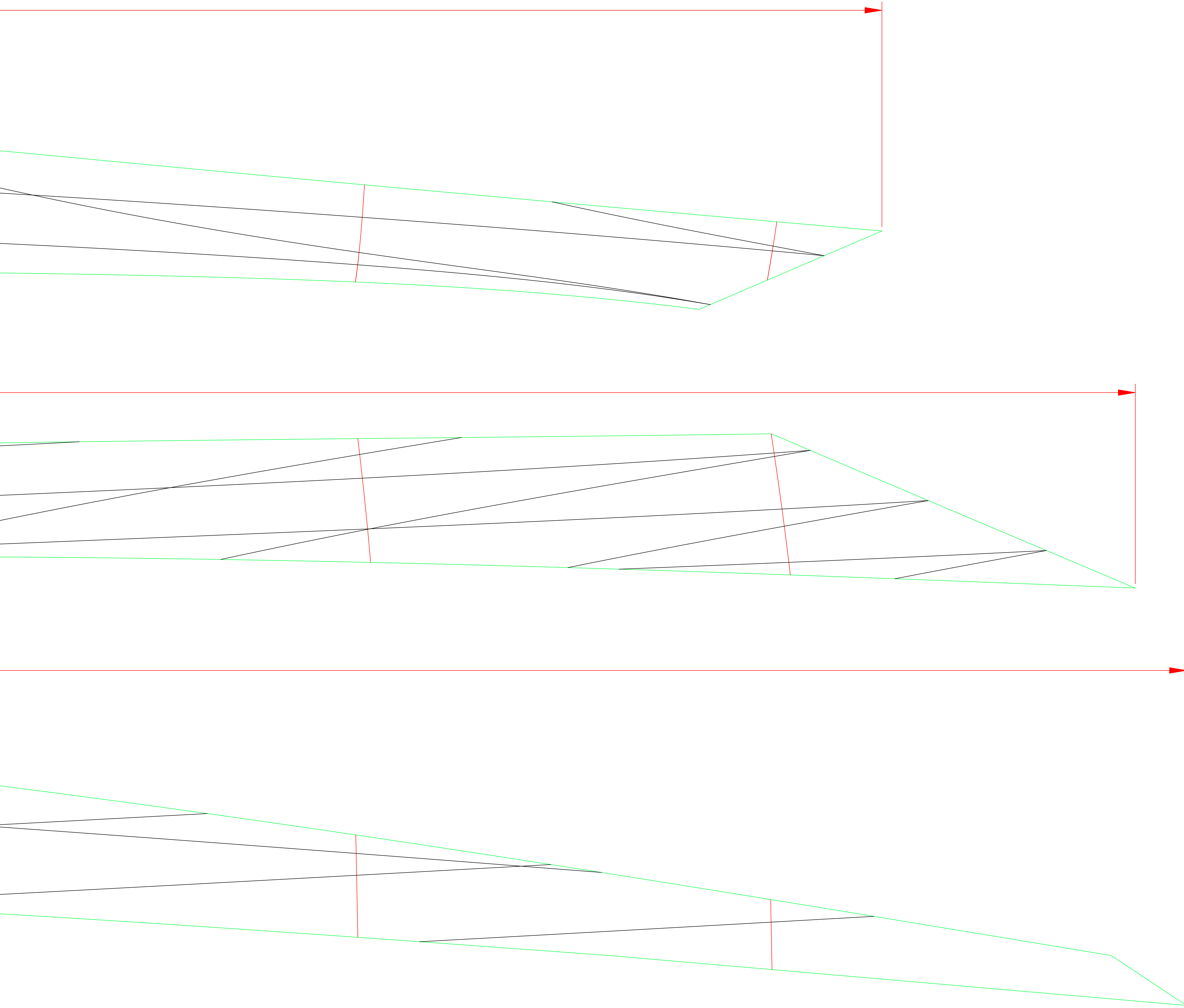

+

+

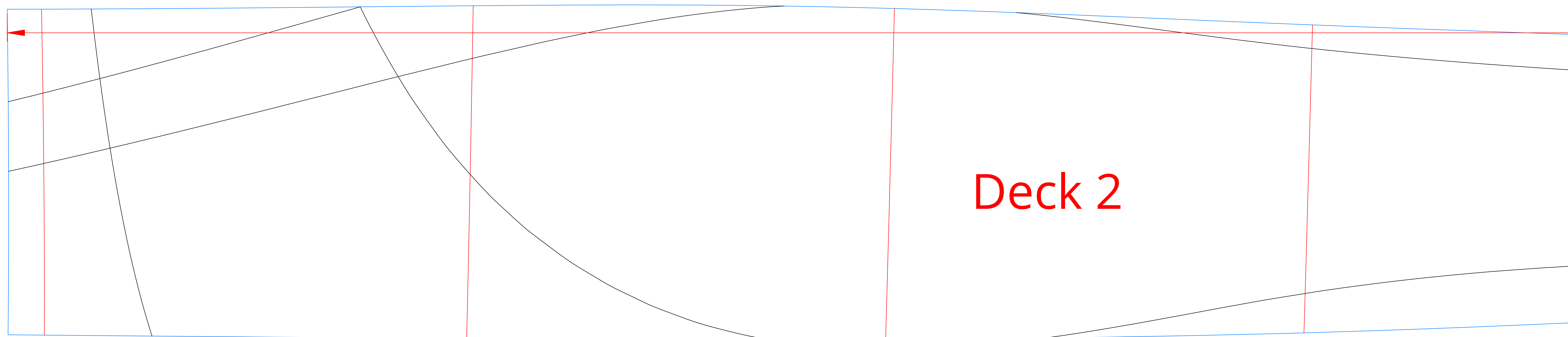
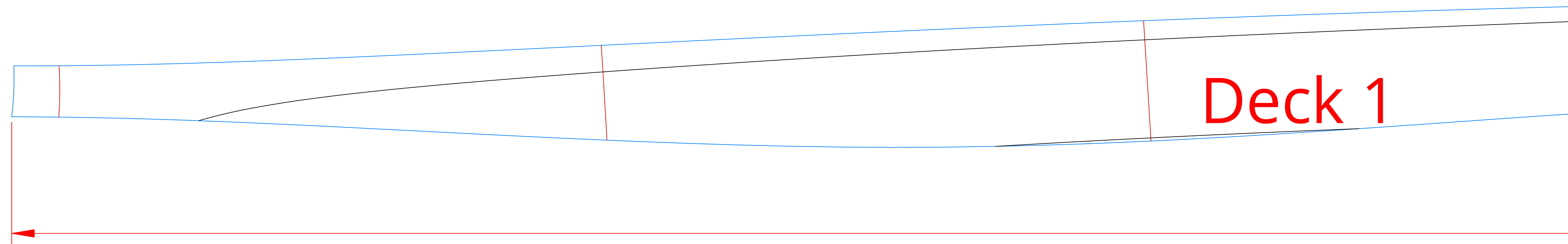

Siskiwit MC Experimental Plate Drawing

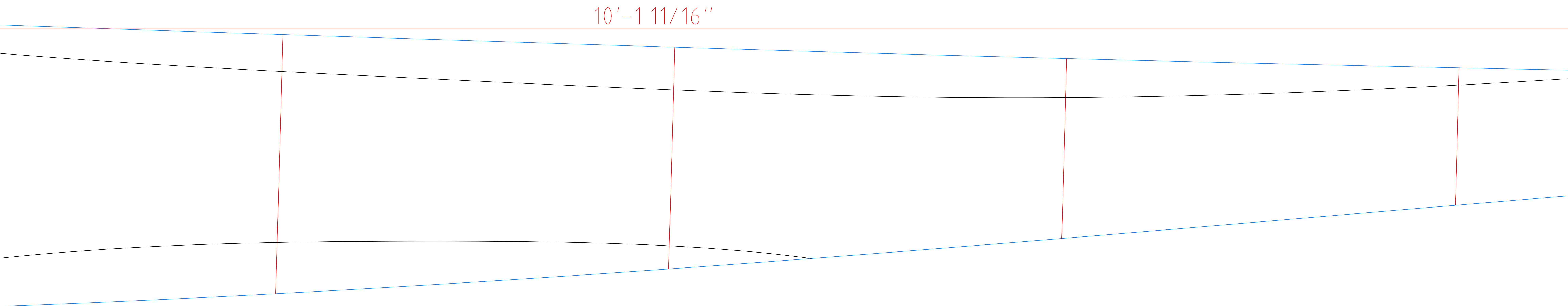
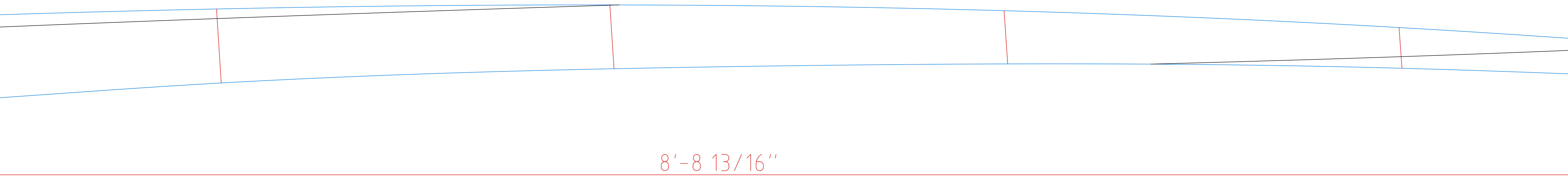

rawing -- www.paddlinglight.com

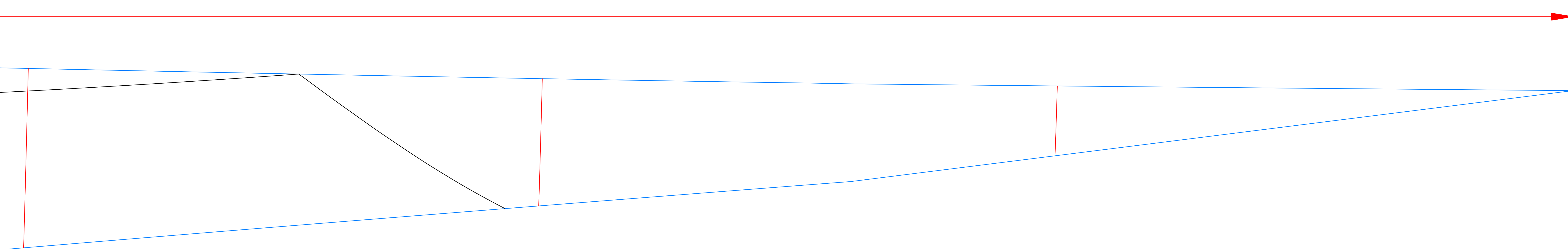
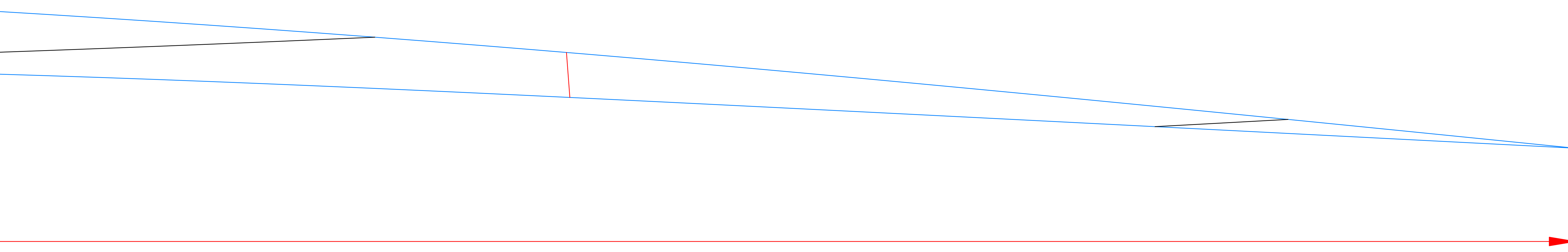

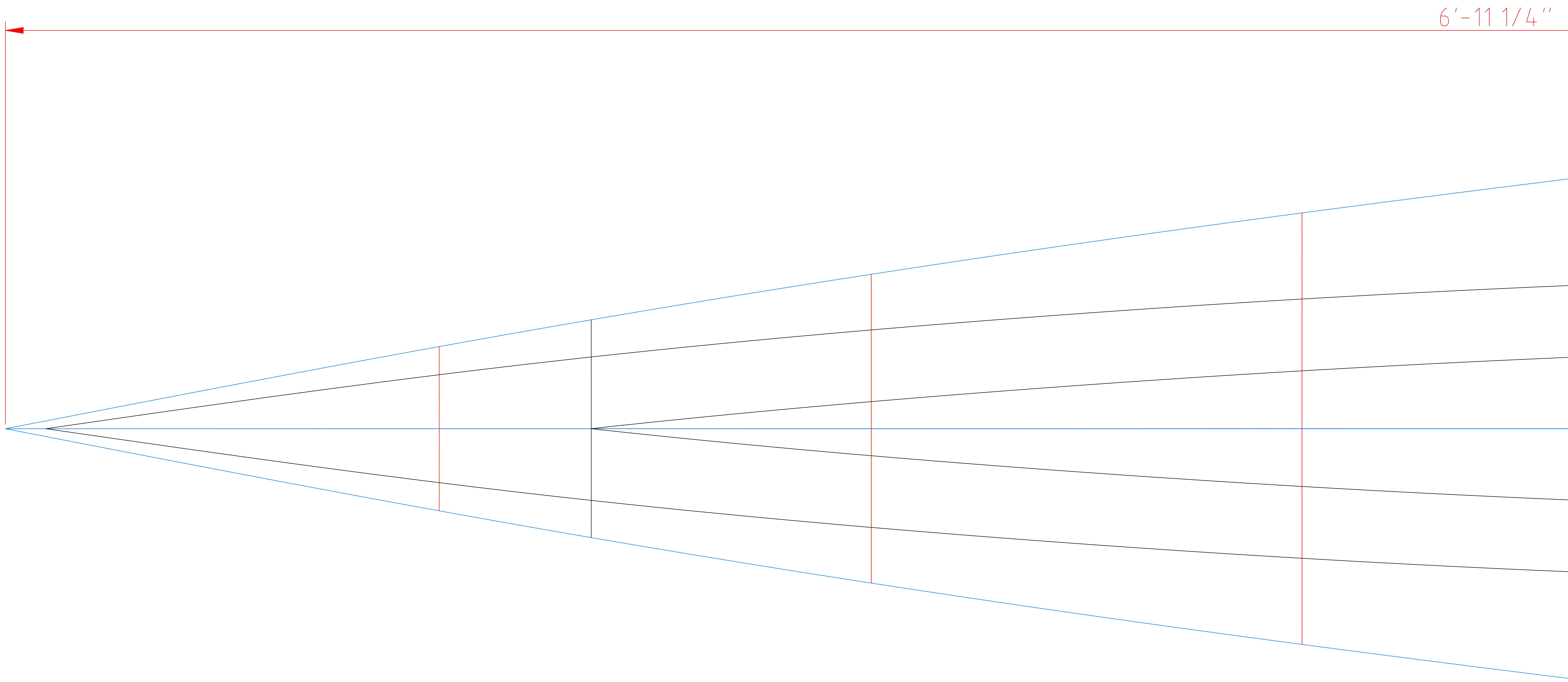

6'-11 1/4"

